

Product sheet

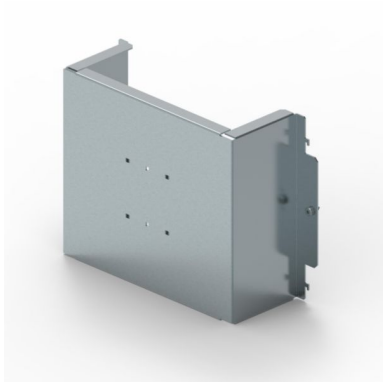

XL³S LEGRAND

Plate for DPX-IS 250 3/4 Poles vertical mounting in
XL3 S 630 & XL3 S 4000 16 modules enclosures

REF. 338920 | EAN. 3414970905765







[> Visit e-catalogue](#)

Product characteristics









- Mounting on side uprights, supplied with fixing screws.

Documentation

TECHNICAL DOCUMENTATION

-  EXB18042_CA_XL3 S 4000_EN.pdf | PDF (82.26Mo)
-  EXB22023.pdf | PDF (97.64Mo)
-  EXB20013_CA_XL3 S 4000_FR.pdf | PDF (83.1Mo)
-  EXB18032.pdf | PDF (101.36Mo)
-  F02370EN-02.pdf | PDF (1.23Mo)
-  LE09860AB.pdf | PDF (1.81Mo)

Agreements & Certificates

-  LOVAG-IT 18.002 | (0.6Mo)
-  LOVAG-IT 18.137 | (1.04Mo)
-  LOVAG-IT 18.039 | (1.1Mo)
-  LOVAG-IT 18.047 | (1.05Mo)
-  LOVAG-IT 18.038 | (1.05Mo)
-  LOVAG-IT 18.096 | (1.03Mo)
-  LOVAG-IT 18.001 | (0.95Mo)
-  LOVAG-IT 17.083-R01 | (1.13Mo)

CATALOGUE PAGE & OTHERS

-  ex223001_0337.pdf | PDF (0.09Mo)