

Product sheet

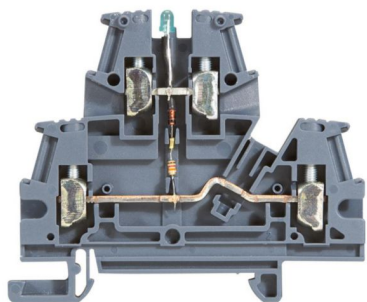

VIKING 3 LEGRAND

Function terminal block, 2 connections , with diode,
Cross-section 4mm² - pitch 6mm - grey

REF. 037156 | EAN. 3245060371562

> [Visit e-catalogue](#)

Product characteristics

- Grey terminal blocks are recommended for standard circuits.
- 2 areas for automatic insertion bridging combs up to 8mm pitch (upper level only for multi-level terminal blocks)
- Easy insertion of conductors thanks to the ergonomic shape of the entry and outlet.

Recommendation / Restriction

- Installation recommended for electrical connection in industrial and tertiary cabinets and enclosures.

The product's benefits

Installation



- A securing pin on the insulating body holds the Viking 3 terminal blocks together for ease of handling and perfect alignment on the rail. The assembly/disassembly of a terminal block is still possible without removing the adjacent terminal blocks

Usage





- Terminal blocks have two marking zones per level allowing a clear, visible and convenient identification of the circuit. Compatible with CAB 3 marking systems.

Documentation

CATALOGUE PAGE & OTHERS

-  [ex223001_0459.pdf](#) | PDF (0.15Mo)
-  [ex223001_0465.pdf](#) | PDF (0.06Mo)
-  [ex223001_0466.pdf](#) | PDF (0.13Mo)

Agreements & Certificates

-  [IMQ-CA02.04204](#) | (0.72Mo)
-  [UL recogn-20101029-E60900](#) | (0.13Mo)
-  [VERITAS \(BV\)-23393/C0 BV](#) | (0.61Mo)
-  [NF App Industri-NF208_1010](#) | (0.28Mo)